

Assembling Instruction For W14

Hardware

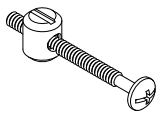

A*4



B*12

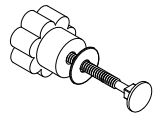

C*2

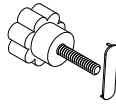

D*4

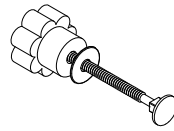

E*2

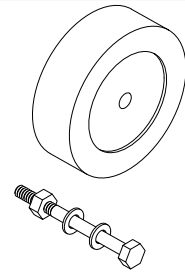

F*2

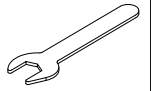

G*1

Components

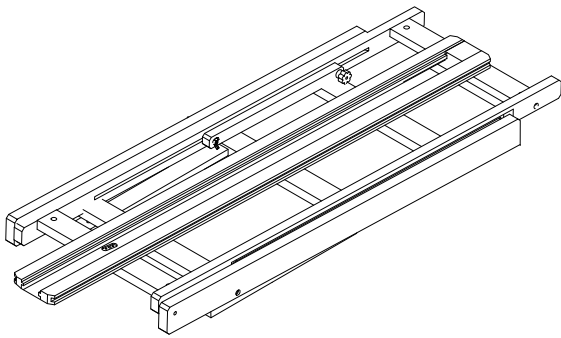

① 1pc

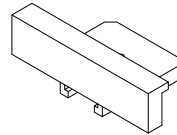

② 1pc

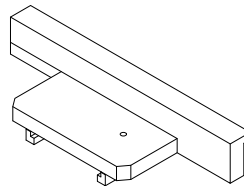

③ 2pcs

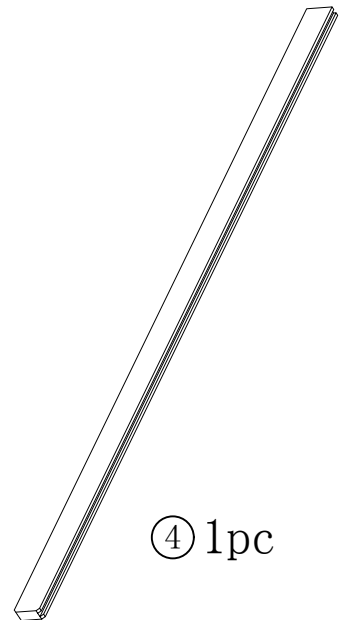

④ 1pc

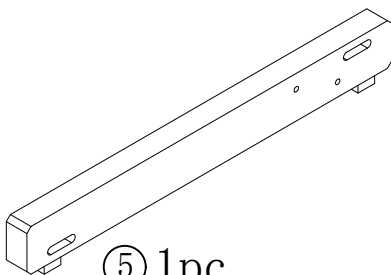

⑤ 1pc

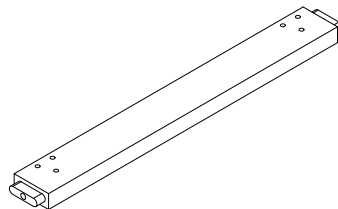

⑦ 1pc

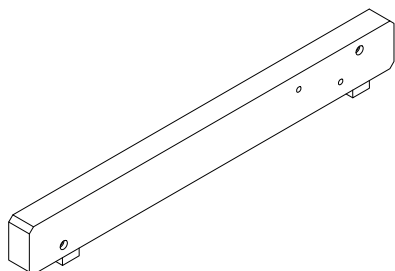

⑥ 1pc

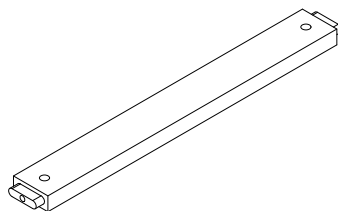

⑧ 1pc

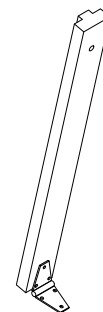

⑨ 2pcs

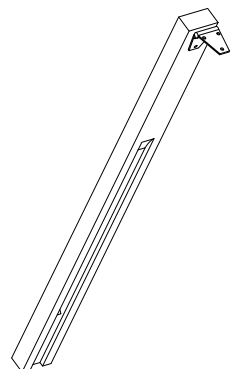

⑩ 2pcs

Assembling Instruction For W14

